

# TECHNICAL DATA EQUIPMENT HOOK

MODEL S-534-200

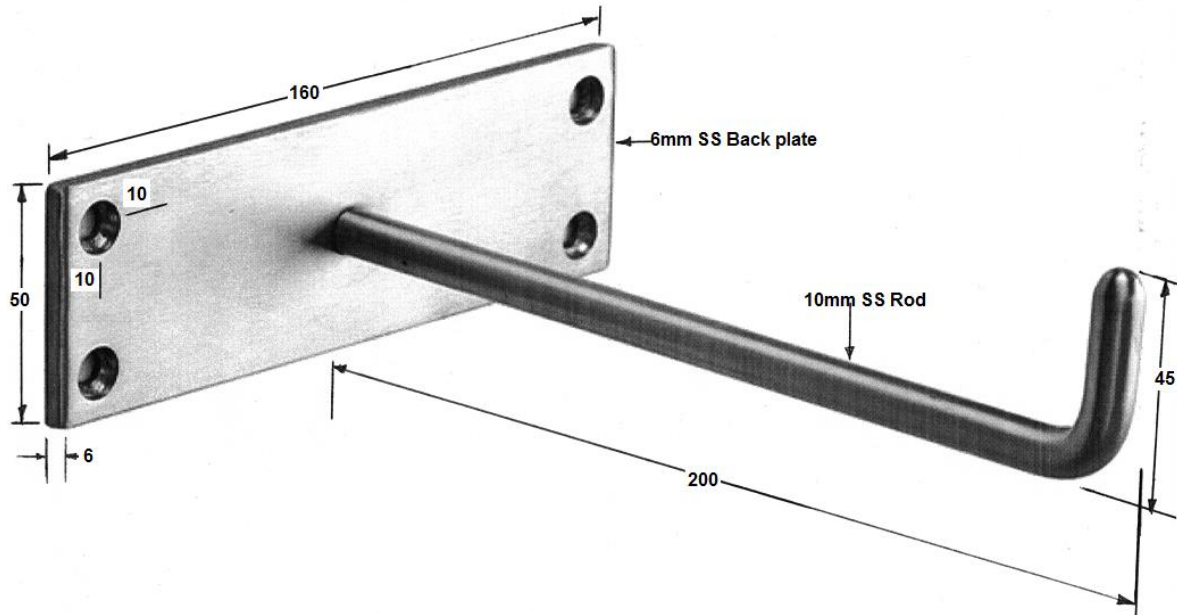

**Size:** (WHD) 160mm x 65mm x 200mm

**Material:** Type 304 stainless steel with a satin finish

**Optional:** Other size made to order

**Construction:**

The backing plate is fabricated of 6mm thick type 304- grade stainless steel

The hook is fabricated from type 304 10mm round bar stainless steel welded and fully welded to the backing plate

**Installation:**

Secure to wall with screws at holes provided.



Phone: (02) 95344031

Fax: (02) 95841030

[www.starwashroom.com.au](http://www.starwashroom.com.au)

Email: [info@starwashroom.com.au](mailto:info@starwashroom.com.au)

ABN: 78 146 670 493 | ACN: 146 670 493

Unit 2 , 41-45 Lorraine St , Peakhurst NSW 2210

P O Box 2210 , Peakhurst NSW 2210